



GOUPIL

ELECTRIC VEHICLES

Brochure 2022



GOUPIL

PIONEER IN ELECTRIC UTILITY VEHICLES

A FRENCH MANUFACTURER...

For more than 25 years, Goupil has been designing and manufacturing electric utility vehicles. Our goal: to provide every professional with a tailor-made solution for their business.

The Goupil range includes three models:

- the G2 : ultra-compact.
- the G4 : most versatile.
- the G6 : best-performing.

...BENEFITING FROM THE STRENGTH OF A LARGE GROUP: POLARIS.

Since 2011, Goupil is part of the Polaris group, the American manufacturer leader in recreational all-terrain vehicles.

The strength of this large group helps us ensure our brand's durability in France and abroad, and allows us to accelerate the development of new solutions for our customers.



25 years
of experience



25,000
vehicles sold



2,500
customers
in Europe



170
employees



11,000 m²
factory in the
Lot-et-Garonne



Distributed in more
than 40 countries

THE BENEFITS OF CHOOSING GOUPIL ELECTRIC VEHICLES



01

Clean and green

Goupil utility vehicles are 100 % electric. With them, play your part in a sustainable future. They do not release any CO₂ when being used, therefore contributing to cleaner air and less nuisance for bystanders and residents during urban service calls.

02

Cost-effective

Opting for an electric utility vehicle will help manage and reduce costs. From day one, using your Goupil allows you to save on energy costs (no more refills at the petrol station), as well as maintenance costs (no need for oil change, belt change or replacing spark plugs...). Recharging costs 2 € for 100 km.

03

Silent and comfortable

Thanks to its electric technology, your Goupil can operate anywhere without causing any inconvenience. For instance, noise pollution often associated with night-time deliveries will no longer be an issue. The electric motor also reduces vibrations while driving, providing more comfort for operators.

04

Adaptable

Goupil has made customisation their biggest asset. When opting for an electric Goupil vehicle, you can choose from a dozen body options available on our catalogue, or send us a specific request. Our R&D department studies every request in order to offer a tailor-made solution: your business deserves an efficient work tool, do not hesitate to contact your local dealer!

05

A unique performance-to-size ratio

The Goupil DNA has not changed, and neither has our motto: design and produce compact size and high-performance electric utility vehicles. Every Goupil has been thoroughly devised to meet our customers' needs: size, payload, volume, manoeuvrability... Every aspect has been carefully designed to support you in your daily work.

06

Designed and manufactured in France

Goupil is first and foremost a French business story. In 1996, Goupil sets up in the Southwest of France, in the department of Lot-et-Garonne (47). The company has always remained true to their local and rural ties. Every day, more than 140 people work in the small town of Bourran to offer you electric solutions, ever more efficient and adapted to your needs.

A WORK TOOL ADAPTED TO YOUR NEEDS



GREEN AREAS

A Goupil vehicle is the perfect partner for the maintenance of your parks and gardens. Vacuuming leaves? Collecting green waste? Watering plants? Transporting work tools? Everything is possible with Goupil!



CLEANING

Both public spaces and private sites need effective solutions to keep the premises clean. Waste collection, high-pressure cleaning, street sweeping... These tasks are made easier with Goupil: your teams can move quickly and operate anywhere, even in the most restrictive spaces.

TOURISM

More and more customers consider acting for the protection of the environment a priority. Sustainable development takes on its full meaning when choosing a 100 % electric Goupil vehicle for the maintenance of your site.



INDUSTRY

The activities of an industrial site involve constant movement of people and goods. Goupil vehicles offer an optimum solution as you can drive anywhere, even inside buildings! Their electric technology allows you to get close to the action without causing any inconvenience. Loading, unloading, moving equipment has never been so easy!



DELIVERY

Last mile delivery solutions require appropriate vehicles. Our Goupil vehicles meet with town centres' highest standards: their electric technology allows them to circulate everywhere. They are also an optimum choice for "stop & go" applications.

BUILD YOUR GOUPIL IN 3 STEPS.

1

CHOOSE A **WHEELBASE** AMONG 4 DIFFERENT MODELS.

GOUPIL-G2

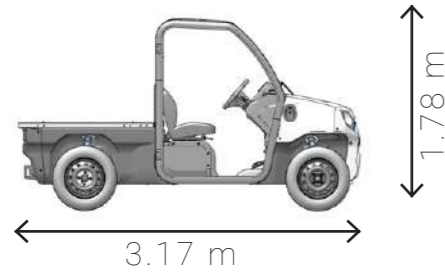

L7e-CU homologation
2 seats
Top speed: 30 km/h

GOUPIL-G4



N1 homologation
2 seats
Top speed: 50 km/h

GOUPIL-G4L

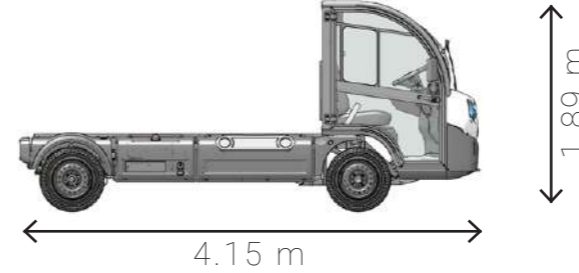

N1 homologation
2 seats
Top speed: 50 km/h

GOUPIL-G6

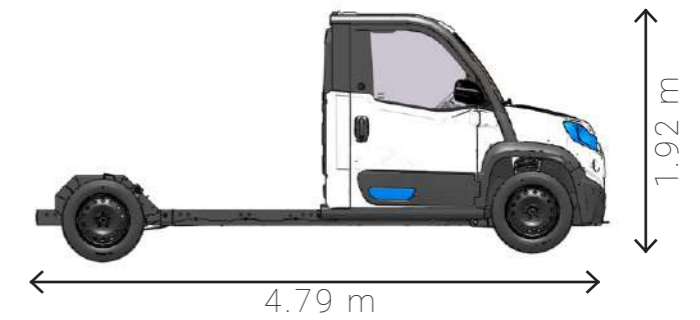

N1 homologation
3 seats
Top speed: 80 km/h

2

DETERMINE **THE RANGE** REQUIRED FOR YOUR DAILY ACTIVITIES.

PRIVATE PROPERTIES | Up to 30 km

GOUPIL-G2

Lead acid: 5.8 kWh
Lithium: 5.2 kWh

GOUPIL-G4

Lead acid: 8.6 kWh

GOUPIL-G6

-

URBAN USE | Up to 70 km

Lithium: 8.6 kWh

Lead acid: 11.5 ou 15.4 kWh*
Lithium: 9.2 kWh

Lithium: 15.4 kWh

SUBURBAN USE | Over 70 km

-

Lithium: 14 kWh* or 21 kWh

Lithium: 28.8 kWh

* Recommended for HP washers or leaf collectors.

3

CHOOSE THE **EQUIPMENT** BEST SUITED FOR YOUR BUSINESS.

HAVEN'T FOUND WHAT YOU'RE LOOKING FOR? GOUPIL OFFERS CUSTOMISED SOLUTIONS, YOU ONLY HAVE TO ASK!

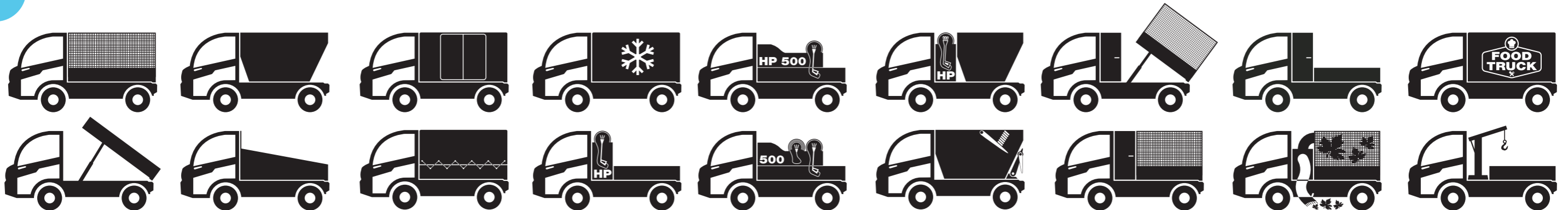

GOUPIL-G2

HIGHLY COMPACT MADE EASY





PAYLOAD
Exceeding 500 kg

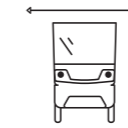

ULTRA-COMPACT
1.10 m wide

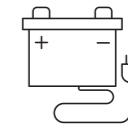

100 % ELECTRIC
Lithium

THE PERFECT BALANCE: COMPACT, ROBUST AND VERSATILE.

Perfectly suspended on McPherson suspensions and mounted with 14 inch wheels, the G2 is at ease on all terrains.

Fitted with low pressure tyres, the G2 can easily venture off-road, on sandy or muddy tracks.

The aluminium cab, fully waterproof, combined with a steel tubular frame give it a lightness and unique resistance for this type of vehicle.

Make the most of its ultra-compact size and drive through even the most restrictive spaces.



Spacious two-seater cab.

The G2 cab is entirely waterproof. The glass doors make for excellent visibility. These can be removed with no impact on road certification.

A modern design with a competitive edge.

The Goupil G2 will bring real change to your business! Its image, both modern and environmentally-friendly, will enhance your own brand image, internally as well as externally.

Driving speed 30 km/h.

The G2 can drive up to 30 km/h, ensuring your operators can safely move between buildings: risks are reduced for people inside the cab, as well as those on the outside.

Type-approval: L7e-CU

With or without doors, the G2 is certified for road use.

PRODUCT RANGE.

THE G2 OFFERS TWO BODY OPTIONS, IDEAL FOR PARKS AND GARDENS MAINTENANCE AND MULTI-SERVICE OPERATIONS.

01

PICK-UP

The all-purpose configuration

- Pick-up with wooden load bed equipped with dropdown and detachable gates.
- Loading area fitting a Euro pallet (120 x 80 cm).
- Ergonomic design: loading height at 80 cm.
- Payload exceeding 500 kg.
- Optional: front mesh extension with tool carrier and/or side mesh extensions, manually operated tipper.



02

BOX VAN

Safe transport of goods

- Box van with 1 or 2 shutters.
- Ergonomic design: loading height at 80 cm and easy access thanks to the shutter.
- Volume: 1.25 m³.
- Side opening dimensions: 820 x 745 mm.

FEATURES.

THE G2 OFFERS UNIQUE PERFORMANCES IN A SECTOR USUALLY RESERVED TO GOLF CARTS: EUROPEAN ROAD CERTIFICATION, COMPLETE WATERPROOF CAB, PAYLOAD EXCEEDING 500 KG, ETC.

Standard

- 3-point seatbelts
- Side indicators
- 2-speed windscreen wipers
- Heated windscreen
- LED headlights
- Cup holders
- 12-volt socket and USB plug
- Wing mirrors
- Adjustable seats (depth)

Optional

- Towing hook
- Forward/Reverse motion buzzer
- Reflective stripes – Class 2
- Roof bar with adaptable options: 2 beacon lights + trifflesh hazard warning triangle
- Bluetooth speaker
- Beacon light mounted on cab
- Standard or heavy duty doors
- Electric heater I 900 W



A BRIGHT AND PRACTICAL CAB WITH MULTIPLE FEATURES

**VERSATILITY WILL
BECOME YOUR NEW
STANDARD**



A UTILITY VEHICLE THAT ADAPTS TO ALL TRADES.

Just like the other models that put Goupil on the map, the G4 adopts the modular chassis concept and offers unrivalled versatility.

Offering tailored solutions for bin or organic waste collection, the maintenance of your parks and gardens, facility management, deliveries...

With a payload of up to 1,200 kg and a maximum range of 199 km, the G4 will meet your every challenge!

With the European N1 type-approval, the G4 is safe for road-use.



Compact size.

With a width of only 1.2 m and a 3.90 m turning radius (M version), the G4 is the right utility vehicle for driving quietly and safely through town centres or private properties (hotel resorts, industrial sites...).

Ideal for customised equipment.

Goupil designs their equipment to ensure perfect integration. We also work with partners to offer you specific solutions: crane, tailgate, special rear load collection body, transport of oxygen tanks, transport of injured people, aerial work platforms, refuse collection body with bin lift...

Spacious two-seater cab.

The G4 cab has been designed to facilitate the work of your operators. The glass doors provide excellent visibility on the outside, particularly on pavements when operating in town centres.

Travel speed of 50 km/h.

With the G4, you can reach 50 km/h, ideal for driving through town centres without slowing ongoing traffic.

TWO LENGTHS, A DOZEN POSSIBILITIES.

ARE YOU LOOKING FOR A COMPACT, SAFE AND ROBUST VEHICLE?
ONE THAT WILL SUPPORT YOU EVERYDAY?
THE GOUPIL G4 IS MADE FOR YOU!

The G4 is intended for professionals who require a vehicle with considerable payload, while remaining compact and highly manageable.

Since 2019, the **G4 is available in a long version** for activities that require a higher carrying capacity. The L version is 50 cm longer, thus extending the loading area.



G4 L transporting scooters in Switzerland.



G4 L for Roland-Garros, in Paris.

A COMPREHENSIVE WHEELBASE.

THE G4 IS A UTILITY VEHICLE WITH MANY AVAILABLE OPTIONS.

Standard

- Adjustable comfort seats with headrests
- 3-point seatbelts
- Circuit breaker
- Immobilizer sensor on driver seat
- Handbrake with torque limiting sensor
- Windscreen with defrosting/demisting device
- Windscreen wiper with washer
- LED headlights
- Rear fog light and reverse light
- High/low speed switch
- High-definition LCD colour display with on-board computer (hour meter, energy consumption...)
- 4-poles charging plug
- Rear cab window
- Proportioning electric braking system
- Acoustic Vehicle Alerting System (AVAS)
- Light sensor
- Seatbelt warning light

Optional

- Tow hitch with trailer plug
- DAB+ car radio
- Pedestrian warning system (bell)
- Reflective stripes – Class 2
- Roof bar with adaptable options (cannot be combined): 2 beacon lights + tricolor hazard warning triangle | 1 beacon light / 1 work light
- Diesel heating unit | 900 - 2,000 W | 15 L tank
- Reversible air-conditioning unit | 1,800 W
- Lateral storage units | capacity 60 L (G4 M version) / capacity 125 L (G4 L version)
- Electric heater | 1,200 W
- Electric power steering
- Cab storage set
- Right and left side guards
- USB plug x2 | 3.15 A
- Door protections



PRODUCT RANGE

THE G4 OFFERS THE LARGEST CHOICE OF EQUIPMENT IN OUR RANGE TO MEET YOUR EVERY NEED.

MAIN BODY OPTIONS

PICK-UP

The basic one

- Reinforced aluminium pick-up equipped with 3 aluminium dropdown and detachable gates.
- Wooden anti-slip and rot-proof load bed floor.
- Optional: standard or half-height mesh cage body | standard solid cage body.



TIPPER

The versatile one

- Reinforced aluminium tipper equipped with 3 aluminium dropdown and detachable gates.
- Cab mounted tipper controller on wander lead.
- Hydraulic cylinder including safety valve and stand (compliant with 3.5t standards).
- Optional: standard or half-height mesh cage body | standard solid cage body.

BOX VAN

Up to 3 shutters

- Box van with 3 m³ of actual useable volume (cubical internal volume, square corners, no wheel arches).
- Loading height: 80 cm.
- Optional: side and/or rear shutters.



WATERING/HIGH PRESSURE WASHER

With a 500 L tank

- Spray lance: with integrated vacuum system for the detergent, user-friendly, left- or right-hand side storage.
- Rotomolded and ride-on tank - no water motion.



HIGH TIP WASTE COLLECTION BODY

Collecting waste

- Half dropdown loading door to both sides.
- Rear rubber stop.
- Hydraulic cylinder including safety valve and stand (compliant with 3.5t standards).

REFRIGERATED VAN

Transporting fresh products

- Class C built-in cold unit.
- Adjustable temperature: from -20°C to +12°C.
- Loading height: 80 cm.

COMBINED BODY OPTIONS

HIGH-PRESSURE WASHER

- Spray lance: with integrated vacuum system for the detergent, user-friendly, side storage.
- Configurable access (left- or right-hand side).
- Tiedown rings.
- No water motion.

LEAF COLLECTOR

- Leaf collector/mulcher with net with Velcro straps on the rear to empty the load bed by tipping.
- Vacuum nozzle with handle and casters for easy handling.
- Mulcher: volume reduction of the leaves up to 6 times (depending on humidity).

STORAGE BOX

- Available with pick-up or tipper.
- Left- and right-hand side door handle with lock.
- Gas struts.



GOUPIL G6

AN EXCEPTIONAL BUSINESS PARTNER





RANGE
Up to 153 km

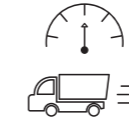

TOP SPEED
80 km/h

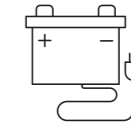

100 % ELECTRIC
Lithium

BIGGER, FASTER, MORE COMFORTABLE.

Expert in electrical utility vehicles for more than 20 years, Goupil rolls out its best performing model yet.

Featuring outstanding performances for its compact size, the G6 has been designed for local stakeholders in urban and suburban areas.

As with all our vehicles, it will meet the requirements of your activity thanks to the many different configurations available: load beds, box vans, waste collectors...

With the European N1 type-approval, the G6 is safe for road-use.



Take design to a whole new level.

From the steel chassis to the drive trains, not forgetting the cabin structure, the G6 has been designed to offer a utility vehicle that is comfortable, safe and robust. Opting for a cabin floor design with front wheel drive gives extensive flexibility to bodybuilders and ensures safe roadholding at all times.

A spacious three-seater cab.

The cab and driving position have been designed to offer optimal comfort to the driver as well as the passengers throughout their workday.

Travel speed of 80 km/h.

With the G6, driving through town centres as well as suburban areas has never been easier. Its speed allows you to drive anywhere without interfering with the traffic flow. Note: with 15 kWh batteries, maximum speed is limited to 60 km/h.

Mode 2 or mode 3 recharging.

The Goupil G6 can be recharged on a household socket or, for faster charging, using an electric charging station, also called Wallbox.

5 000 W heater
3 temperature and
ventilation levels (7 vents)

**Heated wing mirrors,
electrically adjustable and
folding**

**Storage compartment
for A3 sized documents
+ lockable glovebox**

Electric windows

**Sliding storage compartment
underneath the passenger seat**

Adjustable steering wheel
Angle adjustment to help
find the perfect driving
position

Power steering

**DESIGNED
TO EASE
YOUR WORK DAY**

A comprehensive set of standard equipment



**LCD HD
colour display**



**The specific features
control panel** can be
accessed from the driver's
seat (lifting/lowering the
load bed...)

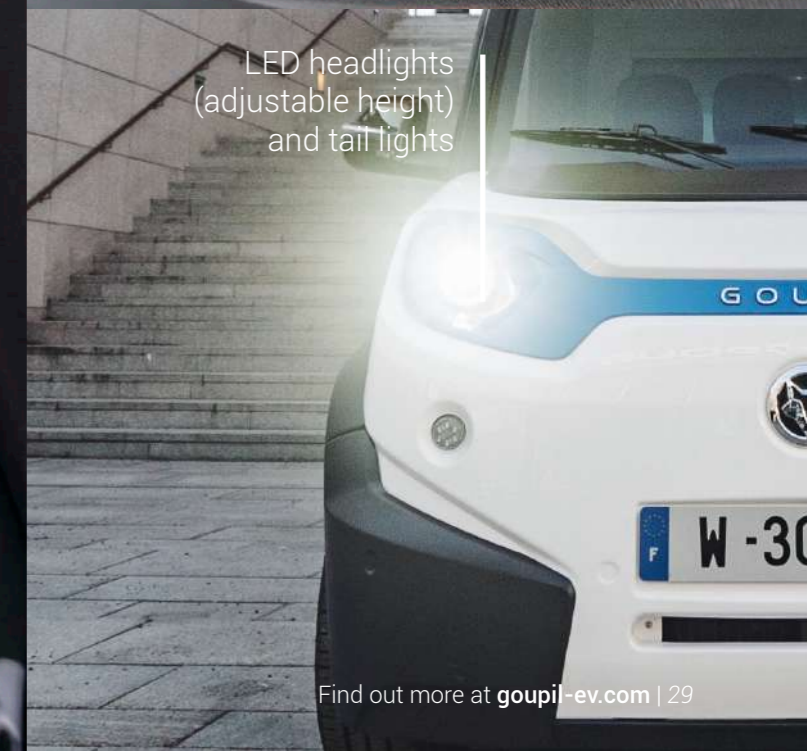

**LED headlights
(adjustable height)
and tail lights**

PRODUCT RANGE

THE G6 OFFERS A RANGE OF EQUIPMENT TO MEET YOUR BUSINESS NEEDS.

BODY OPTIONS FOR GREEN AREAS

PICK-UP

- Aluminium pick-up mounted on a high subframe equipped with 3 detachable gates.
- Load bed height: 92 cm
- Useable loading area: 4.6 m²
- Payload: 966 kg
- Optional: side mesh extensions.



TIPPER

- Aluminium tipper mounted on a high subframe equipped with 3 detachable gates.
- Hydraulic cylinder including safety valve and stand (compliant with 3.5t standards).
- Optional: side mesh extensions.

COMBINED STORAGE BOX

- Available with tipper or pick-up.
- Left- and right-hand side door handle with lock and gas struts.



LOW FLOOR PICK-UP

- Low-floor variant of the pick-up, it offers an extremely low loading height, 40 cm, useful for transporting maintenance equipment such as lawnmowers.



ALUMINIUM MOBILE CONTAINER WITH HYDRAULIC HOOKLIFT

- Developed in partnership with DALBY, this equipment is particularly aimed at green areas maintenance teams for transporting ride-on lawnmowers.
- Hydraulic hooklift.
- Useful loading area: 4.24 m²
- Payload: 725 kg

BODY OPTIONS FOR CLEANING SERVICES



HIGH TIP WASTE COLLECTION BODY

- The high tip waste collection body is very popular for collecting bins in town centres.

REFUSE COLLECTION VEHICLE WITH BIN LIFTER AND SHOVEL

- Developed in partnership with the French manufacturer FAUN, leader in refuse collection vehicles.
- Useable volume: 3.5 m³
- Payload: 400 kg

BULKY WASTE COLLECTOR

- Road-legal steel bulky waste collector, fitted with particularly sturdy removable gates.
- Useable loading area: 4.25 m²
- Payload: 730 kg



BODY OPTIONS FOR SERVICE & MAINTENANCE OPERATIONS

CONVERTED BOX VAN

- In partnership with the French manufacturer SD Services, Goupil has developed tailor-made converted box vans for maintenance trades (electricians, plumbers, painters...).

AERIAL WORK PLATFORM

- In partnership with KLUBB, preliminary studies are underway to develop a G6 with a two people aerial work platform.

THREE-WAY TIPPER

- In partnership with the French manufacturer DURISOTTI, a G6 three-way tipper for the building trade.
- Useable loading area: 4.6 m²
- Payload: 650 kg
- Three-way tipper

THEY HAVE CHOSEN GOUPIL AROUND THE WORLD

City councils

City of Paris France
City of Marseille France
City of Lyon France
City of Bordeaux France
City of Toulouse France
City of Seville Spain
City of Bilbao Spain
City of Palma de Mallorca Spain
City of Valencia Spain
City of Helsinki Finland

City of Geneva Switzerland
City of Lausanne Switzerland
City of Düsseldorf Germany
City of Munich Germany
City of Vienna Austria
City of Budapest Hungary
City of Praha Czech Republic
City of Reykjavik Iceland
City of Brussels Belgium
City of Anderlecht Belgium

City of Amsterdam Netherlands
City of Rotterdam Netherlands
City of The Hague Netherlands
City of Dublin Ireland
City of Brighton UK
City of Bristol UK
City of London UK
City of Dubai UAE
City of Kolding Denmark
City of Malmö Sweden

Delivery & Logistics

Picnic Netherlands & Germany
Flyerman Netherlands
CityHub Netherlands

DHL Netherlands
Eimskip Iceland
Passion Froid France

Chronopost France
Swiss Post Switzerland
Bartolini DPD group, Italy

Industrial sites

Naval Group France
Chantiers de l'Atlantique France
SNCF France
Sanofi France
Seat Spain
Daimler Germany
Volkswagen Germany
Opel Germany
Bayer Germany
Lufthansa Technik Germany

Merck Germany
John Deere Germany
Robert Bosch Germany
Thyssen Group Germany
Siemens Germany
Arcelor Germany & Belgium
Boehringer Ingelheim Austria
Nokian Tyres Finland
FedEx Belgium
B-Rail Belgium

Hitachi UK
Rolls Royce UK
Toyota UK
Rio Tinto Iceland
Heineken Netherlands
KLM Netherlands
Tata Steel Netherlands
Sabic Netherlands
Volvo Sweden
Saudi Aramco Saudi Arabia



Service providers

Compass France
Sodexo France
Derichebourg France
GSF France
Samsic France
Urbaser France & Spain
Ferroviaal Spain
Valoriza Spain

Acciona Spain
Amiat Iren Turin Group Italy
Quendoz Aosta Italy
A2A Milan Italy
Brussels Major Events Belgium
AT&T Israel
Israel Electric Corp. Israel
Wind Israel

EL-AL Israel
Veolia France & UK
Canary Wharf UK
Brighton Hospital UK
Dubai Elec. & Water Authority UAE
Avinor Norway
Iceland Ground Services Iceland
IJmond Werkt! Netherlands

Resorts & Events

Euro Disney France
Center Parcs France & Belgium
PortAventura Spain
Europa-Park Germany
Zoo Brno Czech Republic

Belambra Clubs France
Club Med France
Pierre & Vacances France
Irish Museum Ireland
Al-Ain Zoo UAE

Copenhagen Zoo Denmark
Legoland Denmark
Landal Green Parks Netherlands
Efteling Netherlands
Rotterdam Zoo Netherlands

How about you? Don't wait any longer to find out what our electric utility vehicles can do for you!



GOUPIL CUSTOMER SERVICE

WITH OVER 25 YEARS OF EXPERIENCE IN THE FRENCH AND EUROPEAN MARKET, GOUPIL HAS BUILT AN EFFECTIVE AFTER-SALES SERVICE, RELYING ON THEIR TECHNICIANS' EXPERTISE AS WELL AS A NETWORK OF EXCLUSIVE DISTRIBUTORS.

The successful partnership with our Distributors involves theoretical and practical training sessions with our certified trainer.

A team dedicated to the international market

The Goupil customer service, located at the company's headquarters, have all the necessary technical, material and human resources to effectively handle all queries. Thanks to these qualified teams, Goupil remains close and offers a quick responsive time to customers worldwide.

- Two technicians, dedicated to the export market, support our network of exclusive distributors present in more than 40 countries with technical diagnosis and queries, processing of warranty claims...
- They are assisted by two Customer Service assistants who manage incoming calls, spare parts orders and administrative tasks.
- Together, they play a major part in our commitment towards customer satisfaction, based on responsiveness, efficiency and advice.

Customer focused

Always aiming to offer the best **quality of service** possible, the Goupil customer service department maximises its resources in order to guarantee spare parts availability for 10 years



9 000
references in stock



1,8 M€
in parts inventory
(excl. production)



11 000
orders shipped
per year



92 %
or urgent orders
shipped within 24 hours

ADDITIONAL SERVICES

WARRANTY AND MAINTENANCE

Goupil offers the following warranty for their vehicles and equipment:



Wheelbase

2-year spare parts and labour
European warranty



Equipment

2-year spare parts and labour



Batteries

7-year spare parts and labour

Goupil offers service and maintenance plans:

- An **annual service** to check wear and tear parts and perform adjustments where needed.
- A maintenance contract including 2 service checks per year and a warranty extension.
- A **full service** contract.

RENTAL SOLUTIONS

Goupil offers rental solutions adapted to your profession:

- **Long-term leasing: 36, 48 or 60 months**
- **Short-term leasing (seasonal rental, events...)**

For more information on our rental solutions, do not hesitate to contact us.

SECOND-HAND VEHICLES

In 2018, Goupil set up a unit dedicated to second-hand vehicles. Once they have been returned, these vehicles are **refurbished** and then resold or rented.

CUSTOMISED SOLUTIONS

At Goupil, we know every customer is different, so we offer original solutions, tailor-made to meet your needs. These solutions complement our standard catalogue, and allow for every professional to have a vehicle that's made for them. Contact your local dealer to get your personalised study!



GOUPIL

contact@goupil-ev.com • goupil-ev.com